

LV30200BCT

Rev.F May.-2016

描述 / Descriptions

TO-263 塑封封装 肖特基二极管。
Schottky Diode in a TO-263 Plastic Package.

特征 / Features

低正向压降，低功耗，效率高。
Low forward voltage drop, low power losses, High efficiency operation.

用途 / Applications

用于高频率逆变器，开关电源，续流二极管，OR-ing 二极管，DC-DC 转换器和电池反向保护。
For use in high frequency inverters, switching power supplies, freewheeling diodes, OR-ing diode, dc-to-dc converters and reverse battery protection.

内部等效电路 / Equivalent Circuit

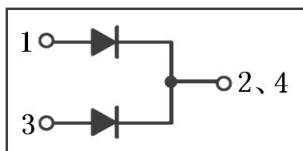

引脚排列 / Pinning



PIN1 : Anode

PIN 2、4 : Cathode

PIN 3 : Anode

放大及印章代码 / h_{FE} Classifications & Marking

见印章说明。 See Marking Instructions.

极限参数 / Absolute Maximum Ratings(Ta=25°C)

参数 Parameter	符号 Symbol	数值 Rating	单位 Unit
Peak Repetitive Reverse Voltage Working Peak Reverse Voltage DC Reverse Voltage	V_{RRM} V_{RWM} V_{DC}	200	V
RMS Reverse Voltage	V_{RMS}	140	V
Average forward rectified Current	I_F	2X15	A
Non Repetitive Peak Surge Current	I_{FSM}	200	A
Thermal Resistance Junction to Case	$R_{\theta Jc}$	4.6	°C/W
Junction and Storage Temperature Range	$T_j T_{stg}$	-40~+150	°C

电性能参数 / Electrical Characteristics(Ta=25°C)

参数 Parameter	符号 Symbol	测试条件 Test Conditions	最小值 Min	典型值 Typ	最大值 Max	单位 Unit
Reverse Voltage	$V_{(BR)R}$	$I_R = 1mA$ $T_a = 25^\circ C$	200			V
Forward Voltage	V_{FM}	$I_F = 5.0A$ $T_a = 25^\circ C$		0.73	0.85	V
		$I_F = 10A$ $T_a = 25^\circ C$		0.80	0.95	V
		$I_F = 15A$ $T_a = 25^\circ C$		0.92	1.15	V
		$I_F = 5.0A$ $T_a = 125^\circ C$		0.58		V
		$I_F = 15A$ $T_a = 125^\circ C$		0.66		V
		$I_F = 20A$ $T_a = 125^\circ C$		0.71	0.85	V
Instantaneous Reverse Current	I_R (Note 1)	$V_R = 200V$ $T_a = 25^\circ C$		4	20	uA
		$V_R = 200V$ $T_a = 125^\circ C$		5	10	mA

注/Notes:

1. 使用极短的测试时间,以尽量减少自热效应。/Short duration pulse test used to minimize self-heating effect.
2. 除非特别注明,数值为一个芯片的参数。/ Unless otherwise noted, values for the parameters of a single chip

电参数曲线图 / Electrical Characteristic Curve

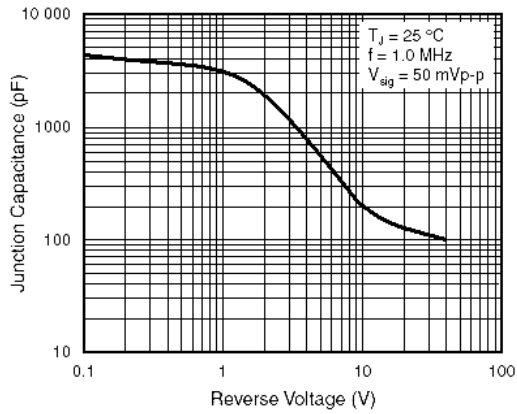
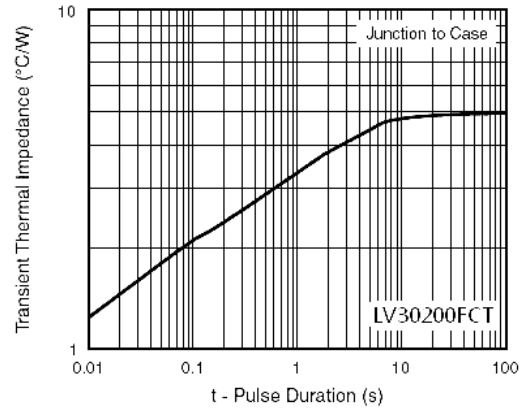
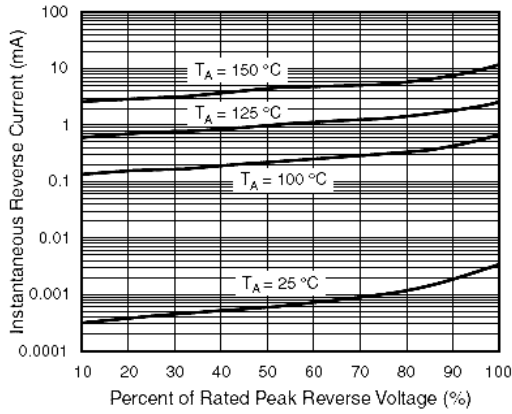
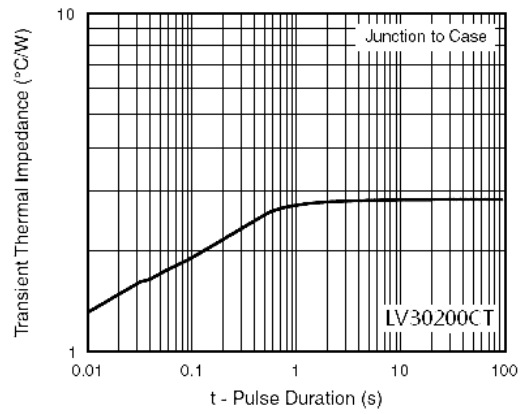
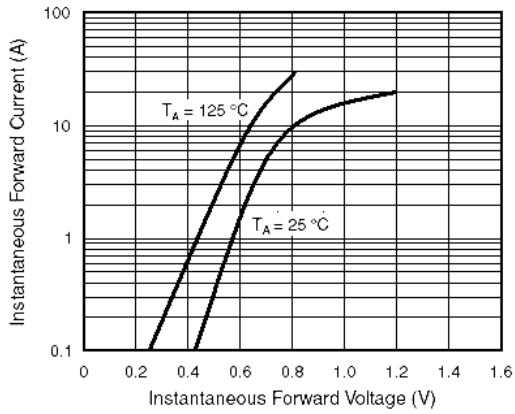

外形尺寸图 / Package Dimensions

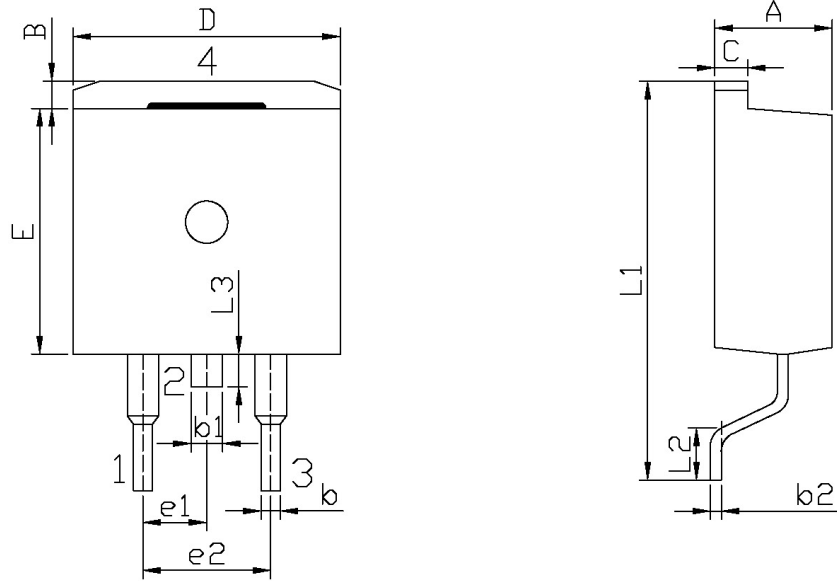

单位: mm

Symbol	Dimensions In Millimeters		Symbol	Dimensions In Millimeters	
	Min	Max		Min	Max
A	4.30	4.70	E	9.00	9.40
B	1.00	1.40	e1	2.34	2.74
b	0.70	0.90	e2	4.88	5.28
b1	1.15	1.35	L1	15.00	16.00
b2	0.40	0.60	L2	2.24	2.84
C	1.20	1.40	L3	1.20	1.60
D	9.80	10.20			

TO-263

印章说明 / Marking Instructions

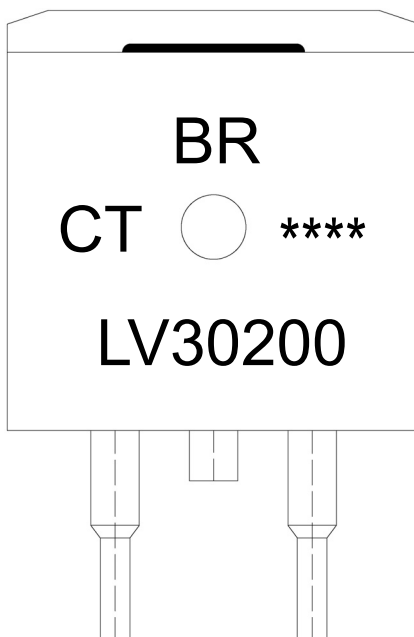

说明：

BR： 为公司代码

LV30200： 为产品型号

CT： 为内部结构

****： 为生产批号代码，随生产批号变化。

Note:

BR: Company Code

LV30200 : Product Type.

CT: Internal Structure

****: Lot No. Code, code change with Lot No.

回流焊温度曲线图(无铅) / Temperature Profile for IR Reflow Soldering(Pb-Free)



说明：

- 1、预热温度 25~150°C，时间 60~90sec;
- 2、峰值温度 245±5°C，时间持续为 5±0.5sec;
- 3、焊接制程冷却速度为 2~10°C/sec.

Note:

- 1.Preheating:25~150°C, Time:60~90sec.
- 2.Peak Temp.:245±5°C, Duration:5±0.5sec.
3. Cooling Speed: 2~10°C/sec.

耐焊接热试验条件 / Resistance to Soldering Heat Test Conditions

温度：260±5°C

时间：10±1 sec.

Temp.:260±5°C

Time:10±1 sec

包装规格 / Packaging SPEC.

卷盘包装 / REEL

Package Type 封装形式	Units 包装数量					Dimension 包装尺寸 (unit: mm ³)		
	Units/Reel 只/卷盘	Reels/Inner Box 卷盘/盒	Units/Inner Box 只/盒	Inner Boxes/Outer Box 盒/箱	Units/Outer Box 只/箱	Reel	Inner Box 盒	Outer Box 箱
TO-263	800	1	800	5	4,000	13" x24	360×360×50	385×257×392

套管包装 / TUBE

Package Type 封装形式	Units 包装数量					Dimension 包装尺寸 (unit: mm ³)		
	Units/Tube 只/套管	Tubes/Inner Box 套管/盒	Units/Inner Box 只/盒	Inner Boxes/Outer Box 盒/箱	Units/Outer Box 只/箱	Tube 套管	Inner Box 盒	Outer Box 箱
TO-263	50	20	1,000	5	5,000	532×33×7.0	555×164×50	575×290×180

使用说明 / Notices